

Aa

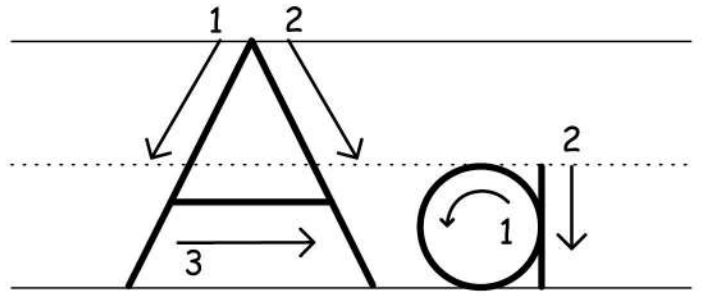

apple



Dan loves apples.  
Apples are nice.  
Maria loves apples  
with sugar and spice!

a

a

A

A

apple

Bb



bear

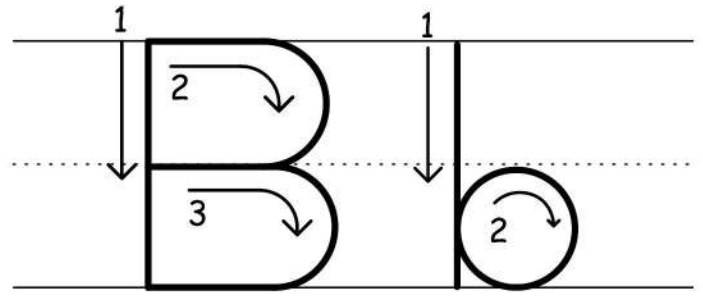

Mama bear has a ball.  
Papa bear is big and tall!  
Baby bear has a book.  
Please look, look, look!

b

b

B

B

bear

Cc



cat



A cat is cat.  
A cat with a hat  
is cat with a hat.  
A cat with a coloured hat  
The cat with the coloured hat  
is sleeping on the mat!

c

c

c

c

c

c

c

c

cat

c

c

Dd



dog

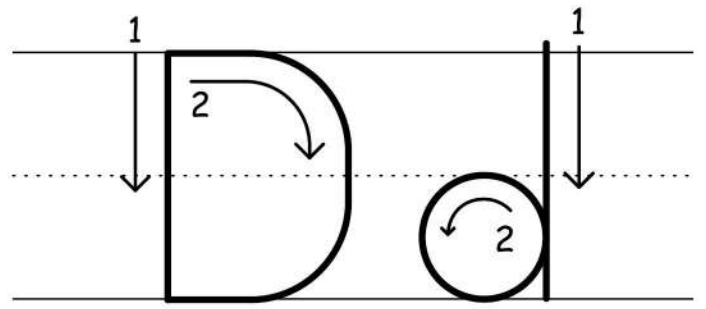
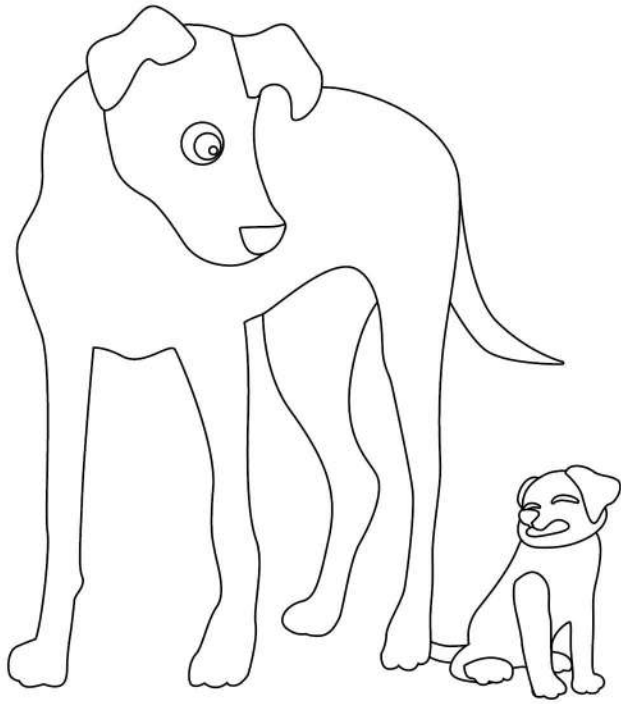

Danny the dog  
is big and strong.  
My dog is Daisy.  
She's small and lazy!

d

d

D

D

dog

Ee

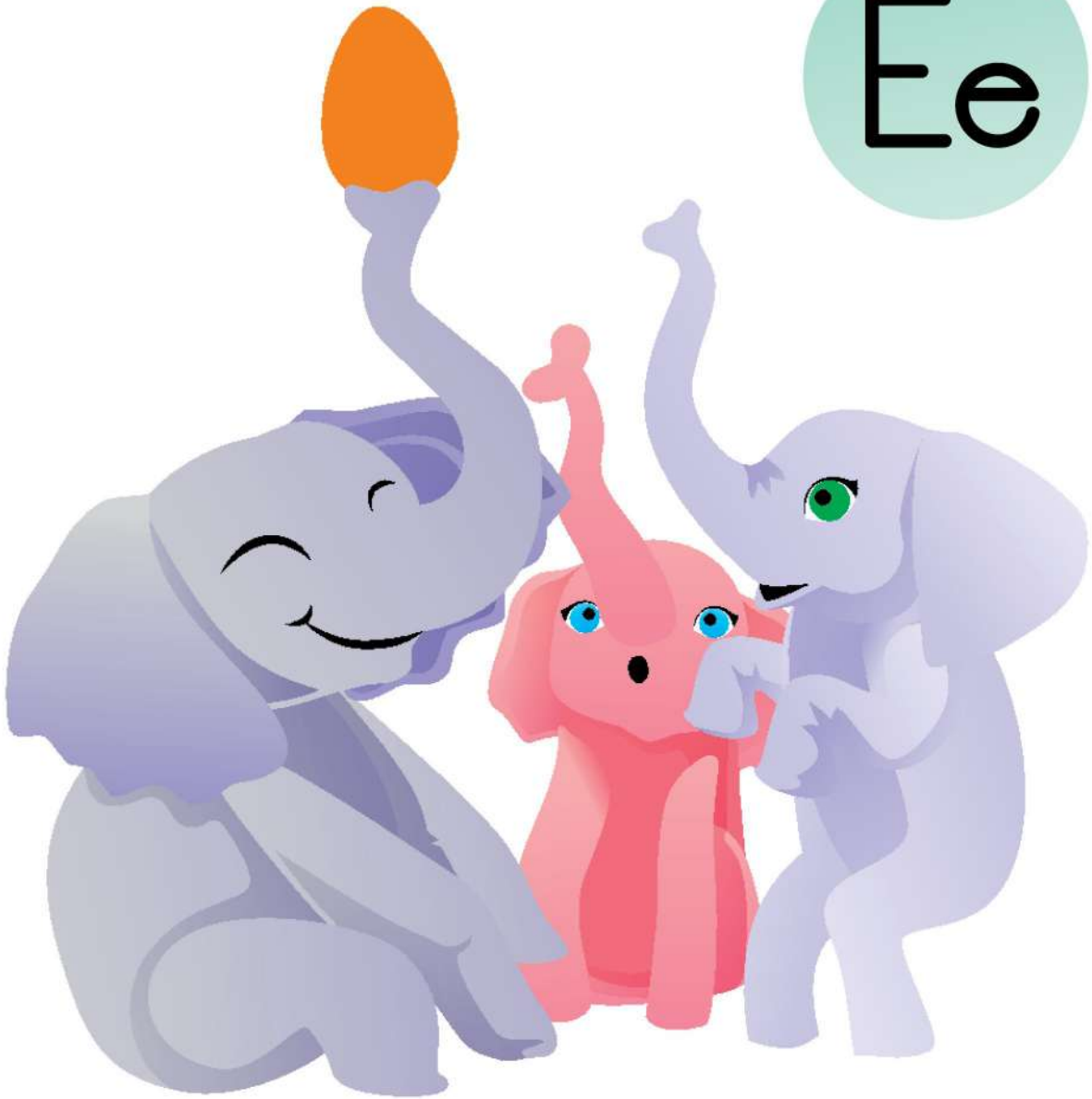

egg

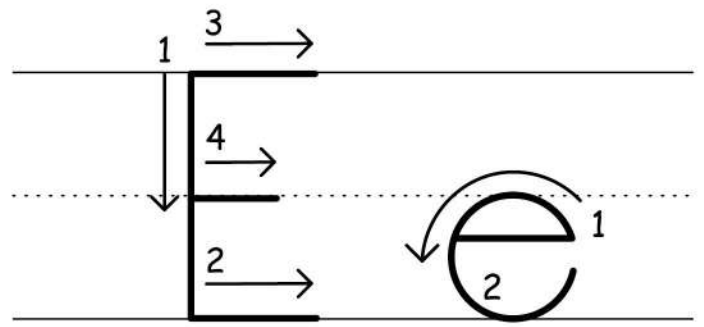
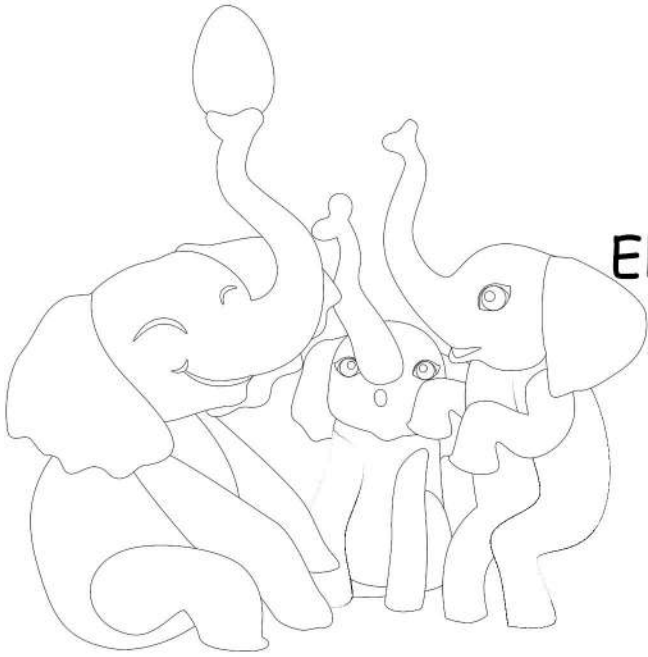

Eli the elephant has got an egg,  
an egg, an egg, an egg.  
But Nelly wants the egg.  
And so does Meg.  
And so does Meg.

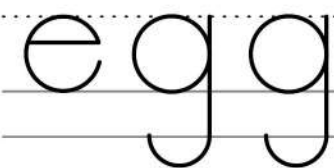
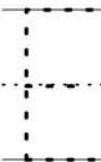
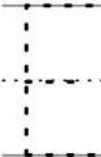

Ff



fish

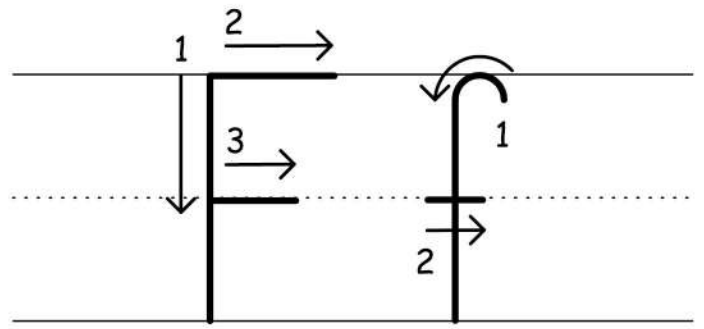

Fanny's fish is in a bowl  
and how he likes to roll!  
Fanny's fish is small  
but Fanny is big and tall!

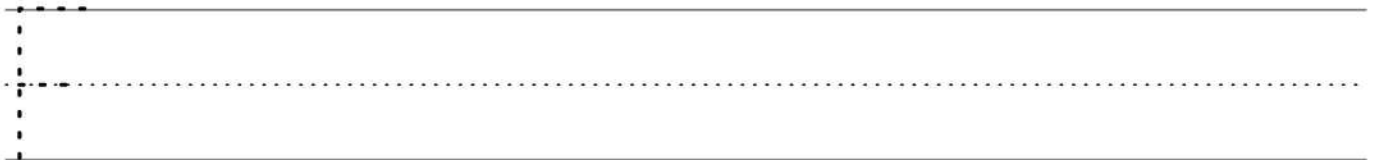
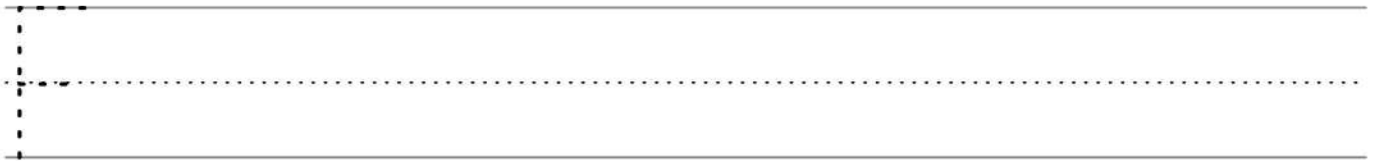
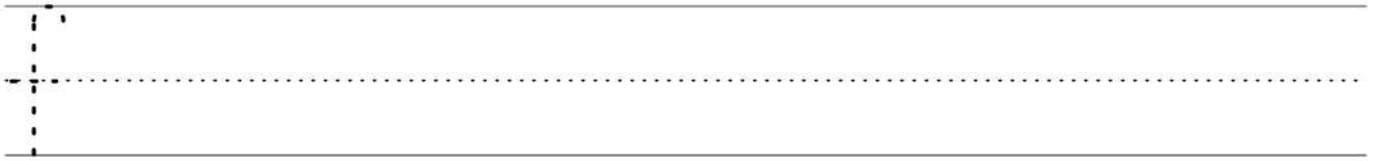

Gg



garden

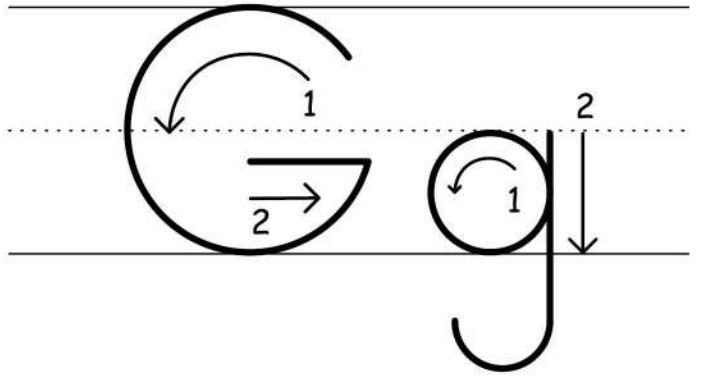
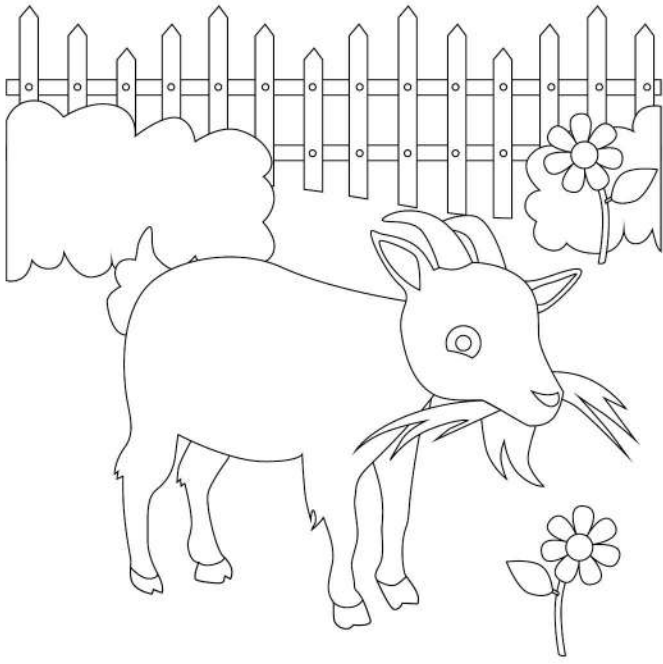

A goat in the garden,  
a goat in the garden,  
a goat in the garden  
is eating grass!

g

g

e

G

garden

Hh



hat

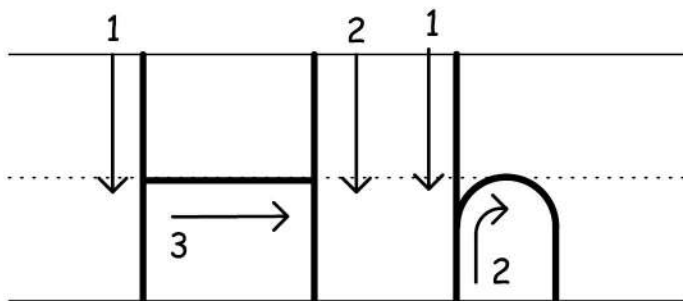

One hat's on her head,  
one hat's on her head,  
one hat's on her head  
and two are on her bed!

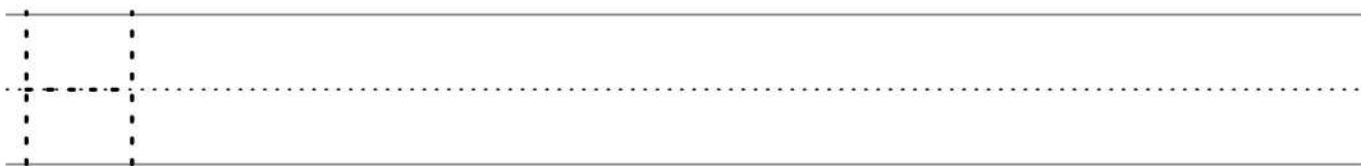
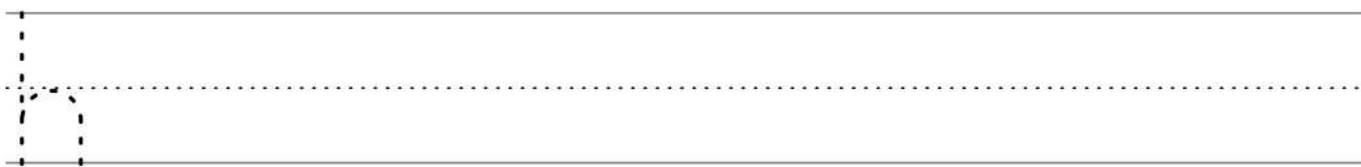

I i



Indian

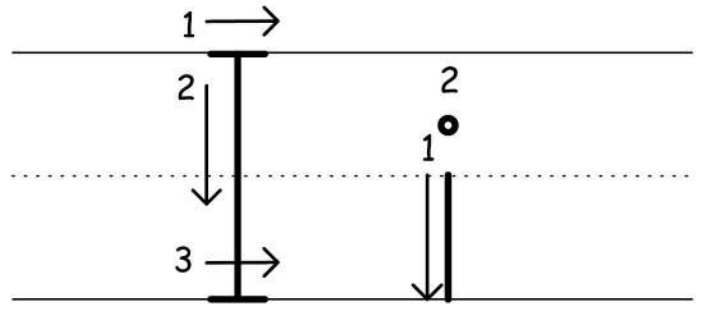

One little Indian,  
two little Indians,  
three little Indians, four.  
The little Indian loves me  
and I love him more!

i

i

i

i

Indian

Jj



jungle

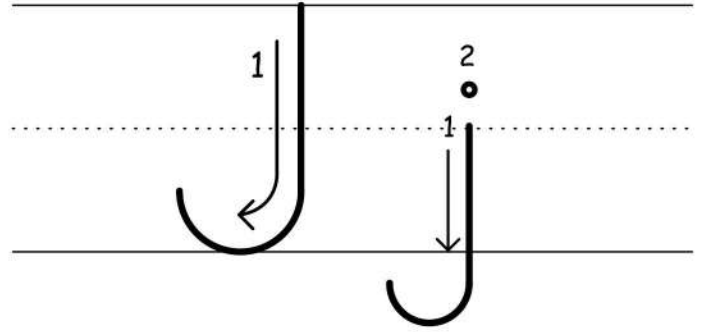
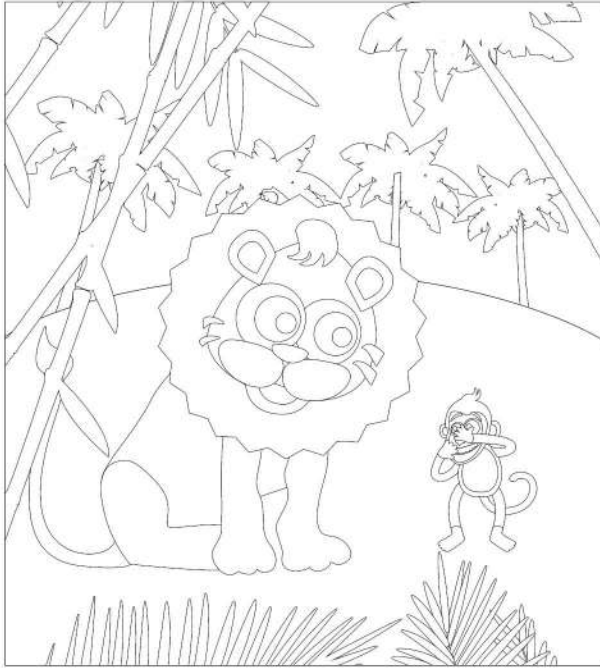

The king of the jungle is Leo.  
The joy of the jungle is Joy.  
She's small and very coy.

j

j

J

J

jungle

Kk



kite

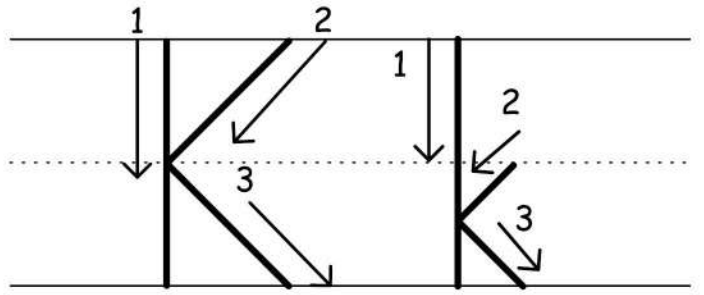
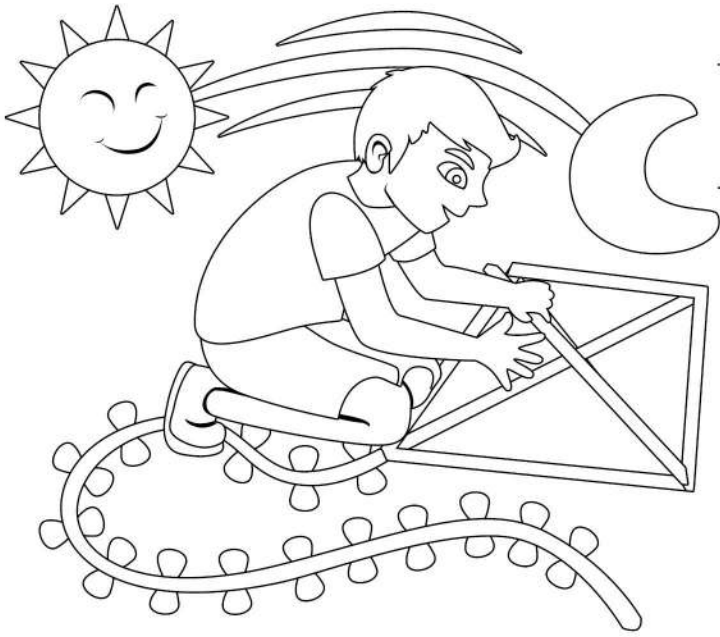

Ken is making a kite,  
a kite, a kite.  
He is working hard  
from morning 'till night!

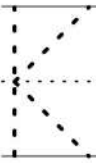
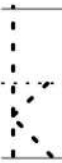
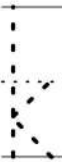

kite

LI



lion

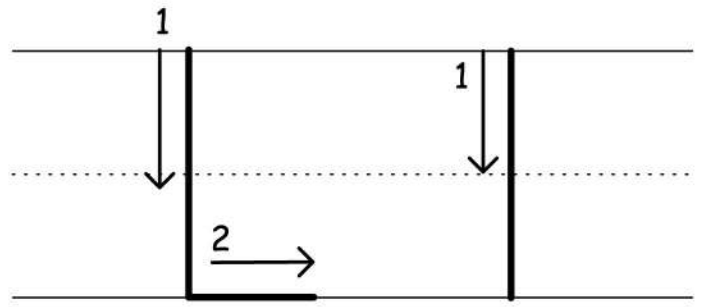

Lions are big.  
Lizards are small.  
Larks are pretty and  
leopards are tall!

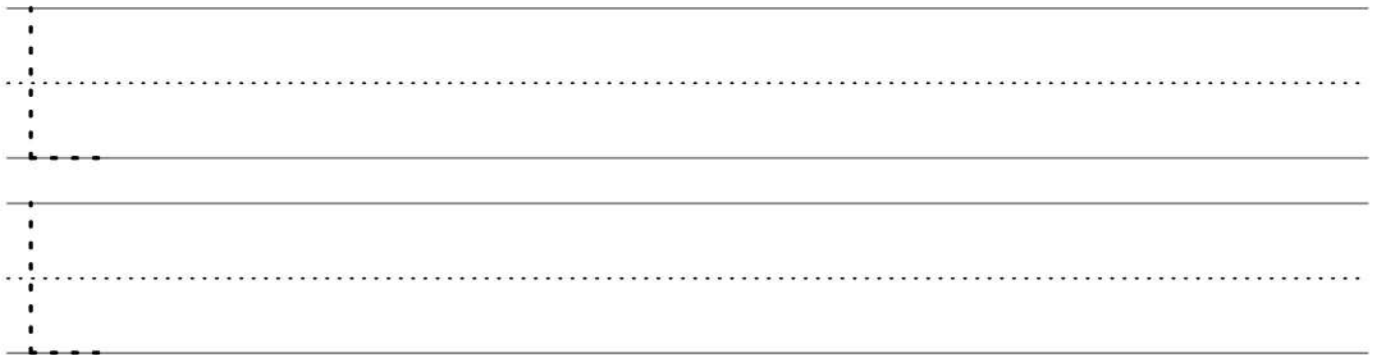
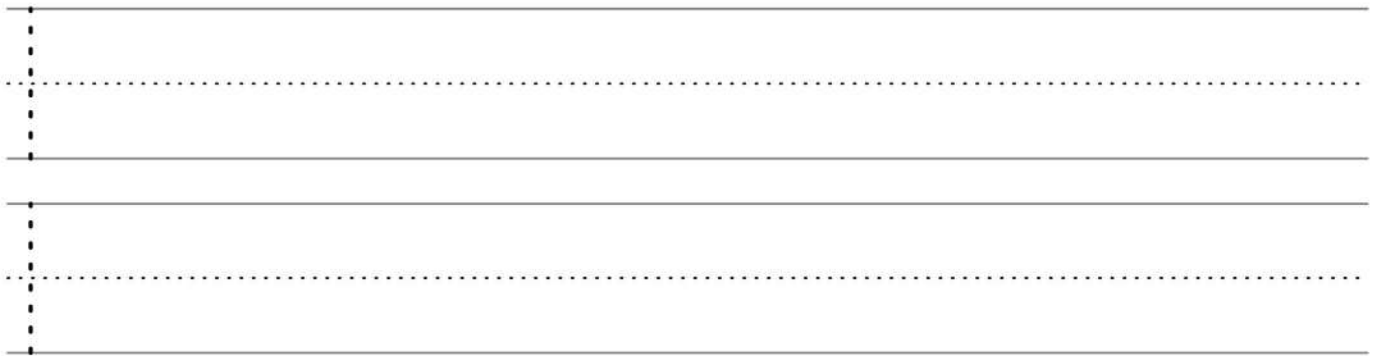

lion



Mm



monkey

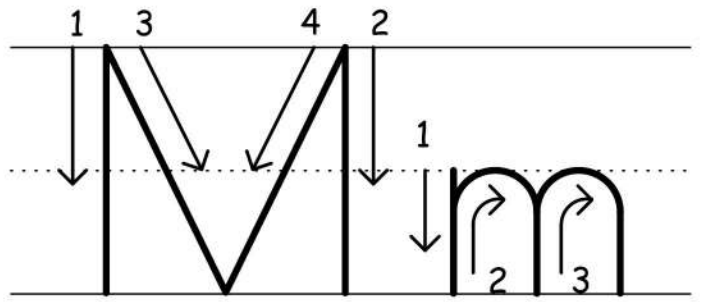
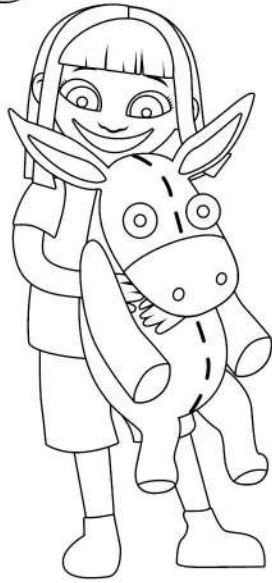
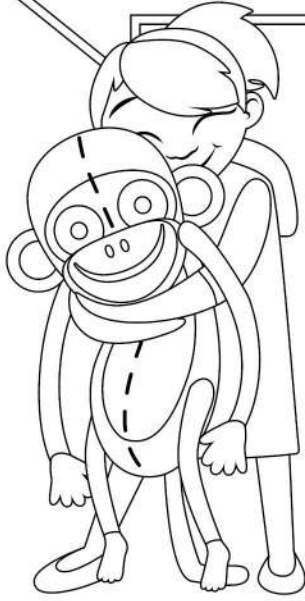
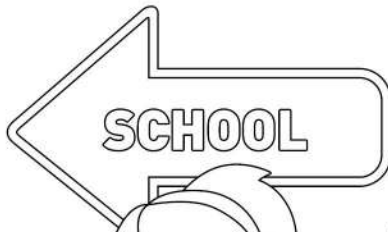

Mandy has a monkey  
and Molly has a donkey!  
Mandy and Molly go to  
school  
and that is really cool!

M M

M M

M M

M M

monkey

Nn



name

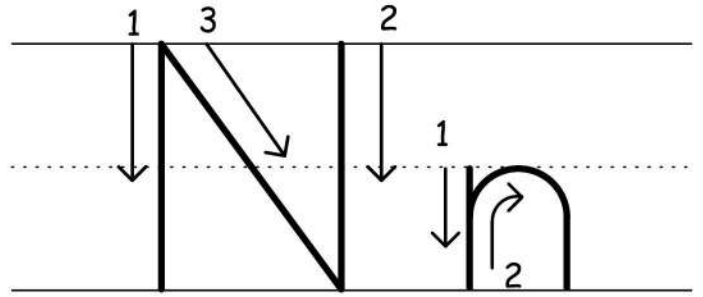

Her name is Anna.  
She's got a banana.  
Her name is Lana.  
She's got NO banana!

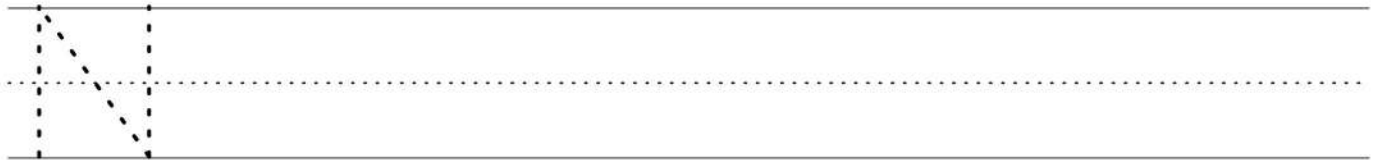
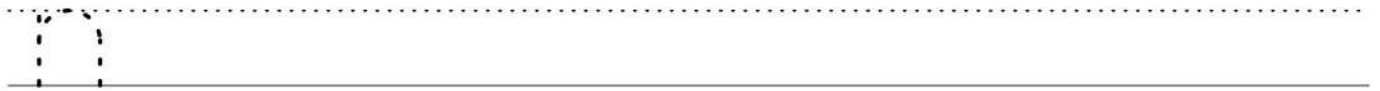
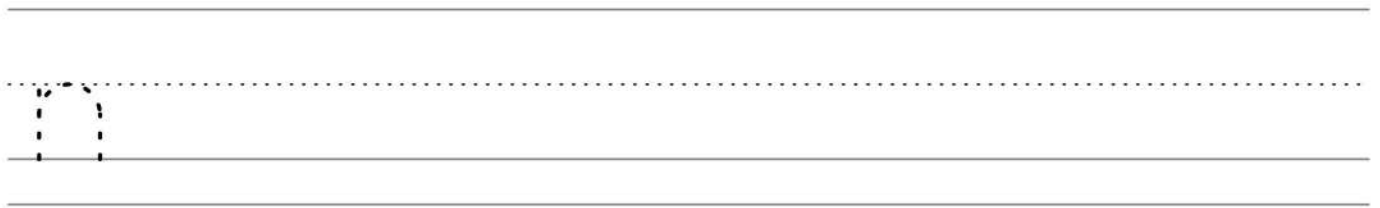



o'clock

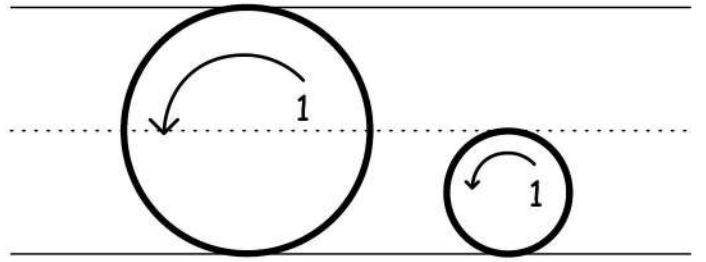
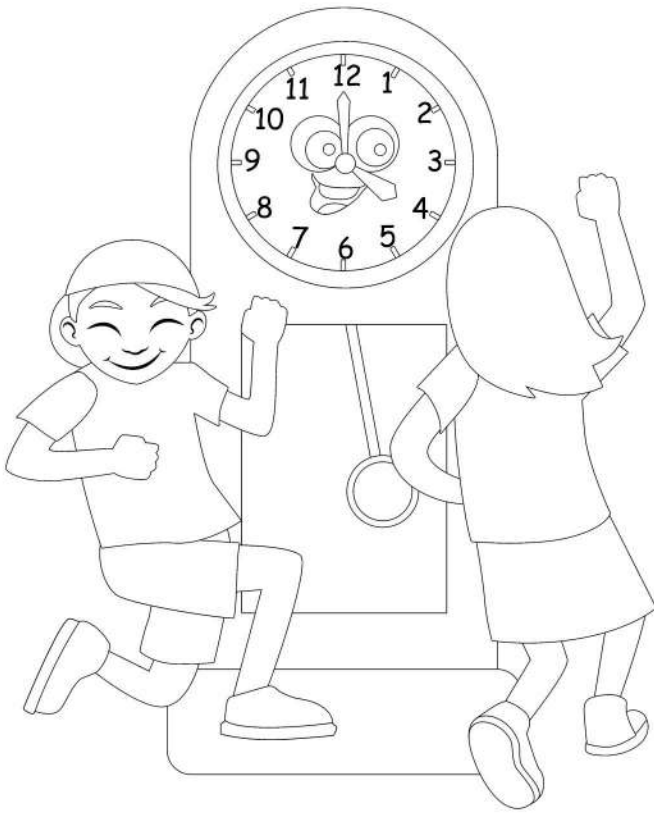

1.00 o'clock, 2.00 o'clock,  
3.00 o'clock, rock!  
4.00 o'clock, 5.00 o'clock,  
6.00 o'clock, rock!  
Rock, rock, rock  
'round the clock tonight!

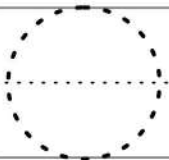
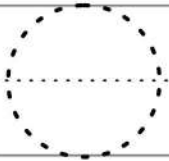

o'clock

Pp



pen

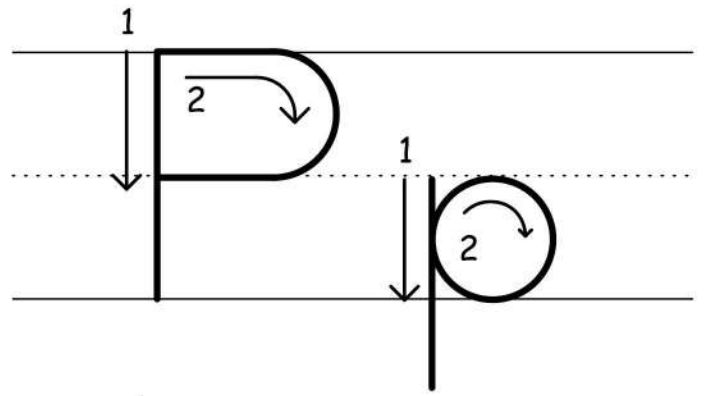
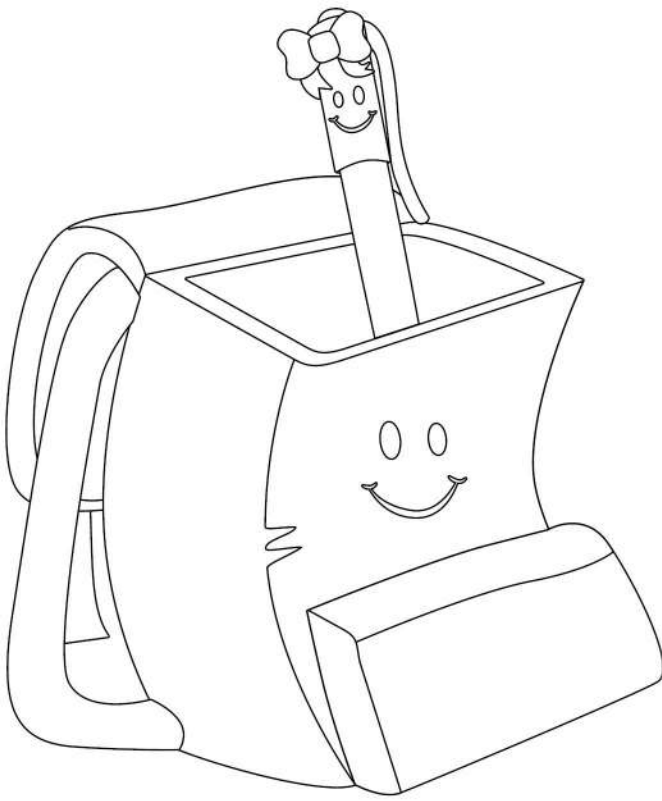

A pen, a pen, a pen.  
A pen is in the bag.  
A pen is in the bag  
and it's pink, pink, pink.

P

P

P

P

pen



Qq

queen

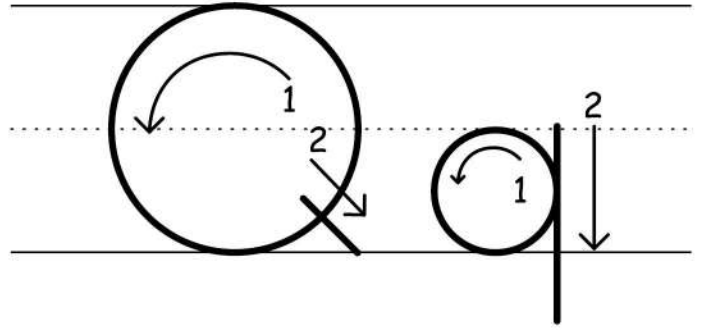

See the queen.  
Her dress is violet.  
Her name's Ann  
and she's very quiet!

q

q

q

q

queen

Rr



rat



R r

A rat in the road

A rat in the road

Rat, rat, roll

There's a rat in the road.

r

r

R

R

rat

••

Ss



socks

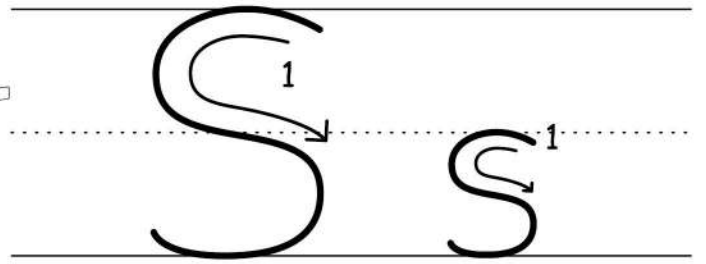

Sofia's socks are red.  
Sonia's are blue.  
These socks are purple  
and they are for you!

s

s

S

S

socks

T t



tiger

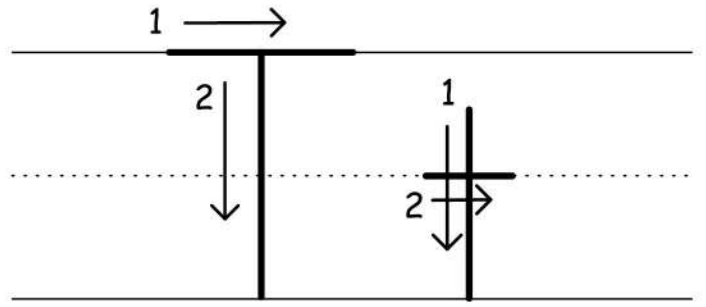

Timmy has a tiger.  
Timmy is a boy.  
Timmy loves the tiger  
but it's not a toy!

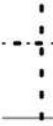
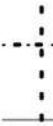

tiger



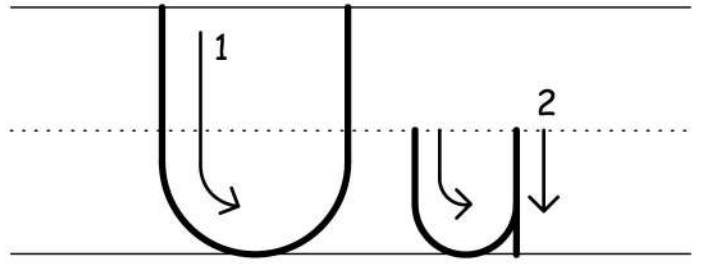

My uncle has an umbrella.  
His name is Ned.  
He's at the sea and  
his umbrella's red!

u

u

u

u

umbrella

Vv



van

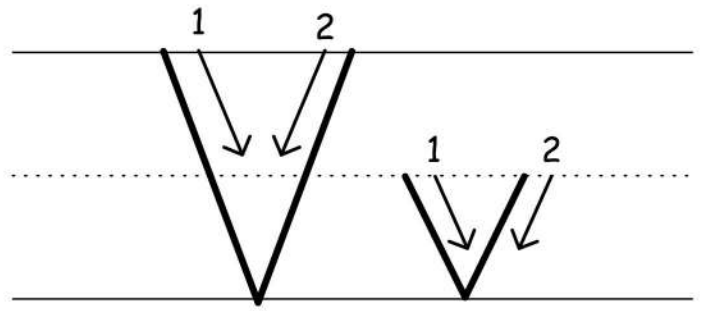
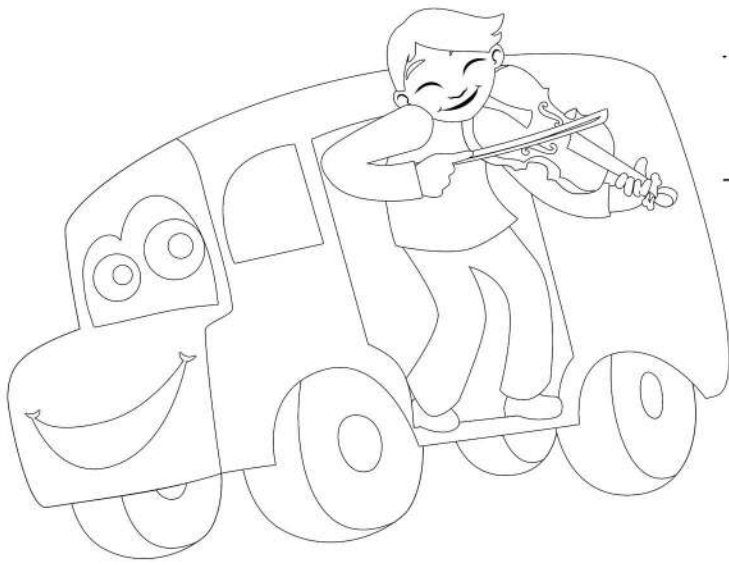

A violin in the van,  
van, van, van.  
The man has a violin  
and he's in the van,  
van, van, van.  
The man and his violin  
are in the van,  
van, van, van

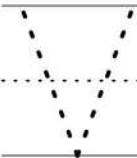

van

Ww



water

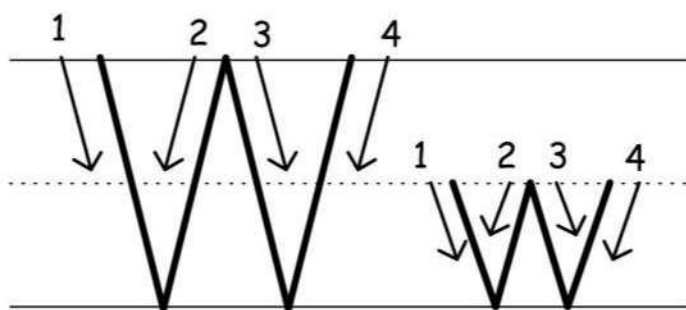

Water is no food  
but it's very good.  
Water is for me and you.  
It's for the wide world, too!

w

w

W

W

water

X x



box

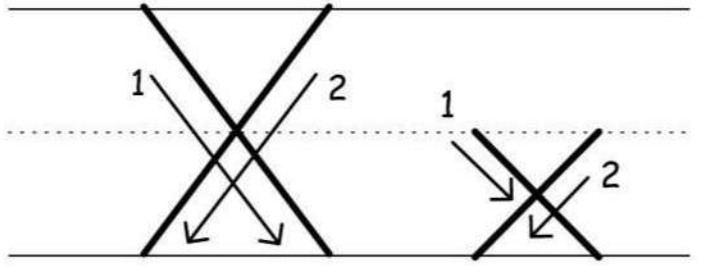

A fox, a fox, a fox.  
The fox has got a box.  
What's in the box?  
A fox, a toy fox!

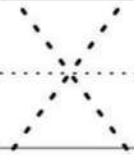
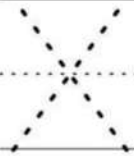

box



Y y

yo-yo

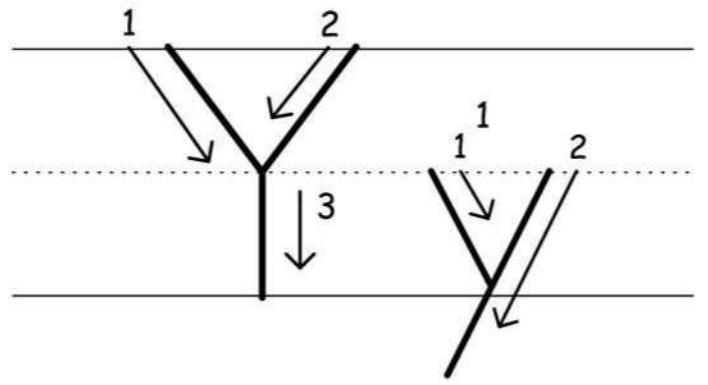
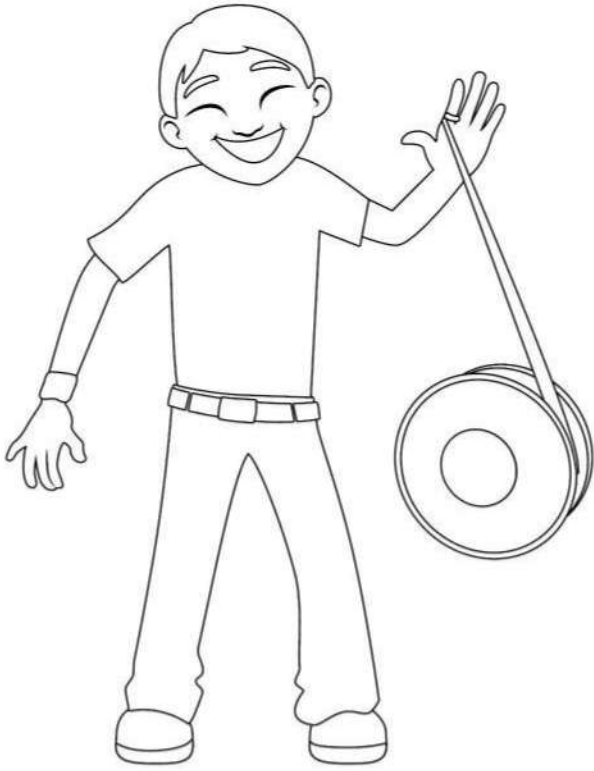

I'm Yong.  
I have a yo-yo.  
My yo-yo's yellow,  
yellow, yellow, yellow.  
I'm a nice fellow.

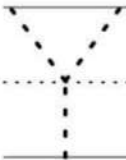
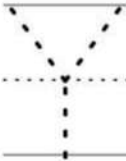

yo-yo

Zz



zebra

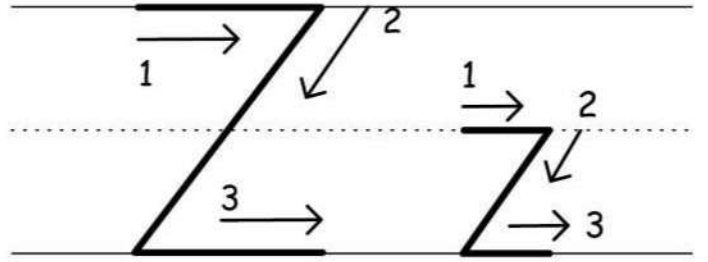
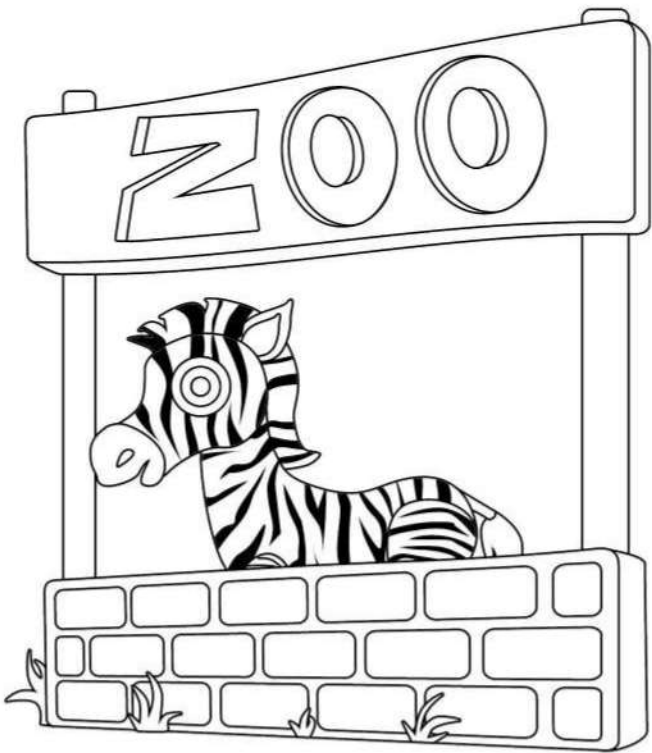

Zoo, zoo, zoo.  
A zebra's in the zoo.  
A zebra's in the zoo.  
Zoo, zoo, zoo.

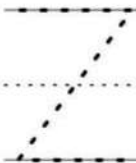
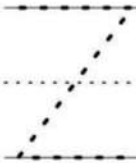

zebra